



INSTALLATION MANUAL



HUGINN R



AC220-240V | 50/60Hz | IP20 | Die cast

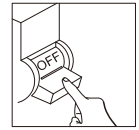
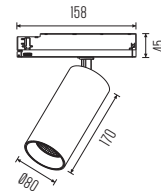
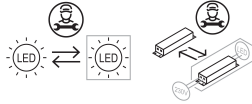

Do not operate with power supply connected.

1

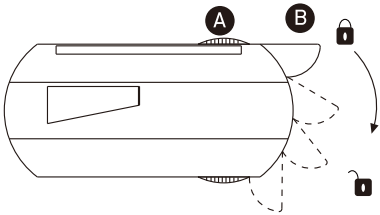

To mount the track adaptor into the track system, first check that the selector knob **A** is at OFF position and the adaptor lock **B** is disengaged.

2

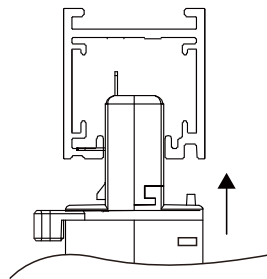

When installing the adaptor into the track, ensure that it is orientated correctly.

3

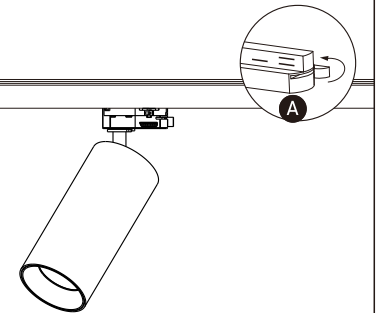

Rotate adaptor lock **B** clockwise 90° to connect the adaptor to the neutral circuit.

4

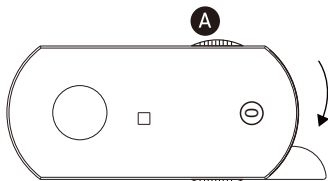

Rotate selector knob **A** to the position of desired circuit.

4a

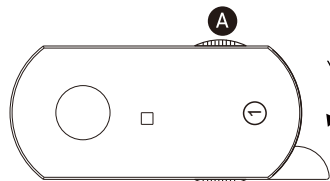

Circuit 1: Rotate the knob **A** 90° clockwise from the starting position OFF, to connect circuit 1.

4b

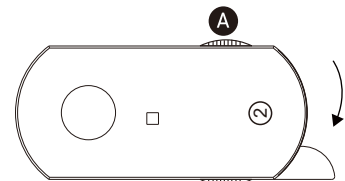

Circuit 2: Rotate the knob **A** 90° anti-clockwise from the starting position OFF, to connect circuit 2.

4c

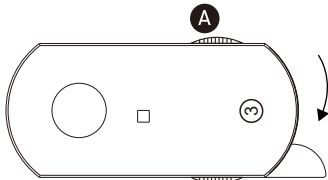

Circuit 3: Rotate the knob **A** 180° clockwise from the starting position OFF, to connect circuit 3

5

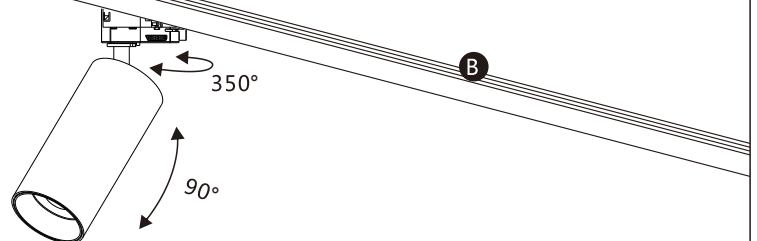

The installation is complete, support can be freely rotated 0°-350° the lamp body can be freely rotated 0°-90°.

Warnings:

1. Make sure that the product is installed properly before connecting to electricity.
2. Do not cover the fitting.
3. Maintenance and installation should only be carried out by a professional electrician.